

---

## High Sensitive Digital-Unipolar Hall Effect Sensor

---

### Features

- Digital Unipolar Hall sensor
- High chopping frequency
- Supports a wide voltage range
  - 2.5 to 24V
  - Operation from unregulated supply
- Wide operating temperature range
- Factory-programmed at end-of-line for optimum
- Reverse battery protection (up to 28V)
- Over-voltage protection at all pins
- Robust EMC performance
- Solid-state reliability
- Small package
  - 3-pin SIP -(UA)
  - 3-pin SOT23 -(SO)

### Output state

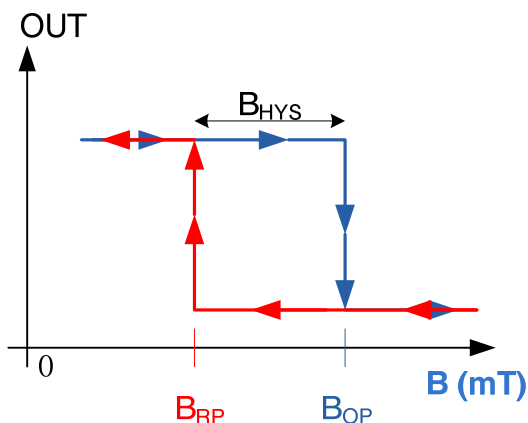

### Applications

- Flow meters
- Valve and solenoid status
- BLDC motors with sensors
- Proximity sensing
- Tachometers

### Description

The SC243X family, produced with Bi-CMOS technology, is a chopper-stabilized Hall Effect Sensor that offers a magnetic sensing solution with superior sensitivity stability over temperature and integrated protection features.

Superior high-temperature performance is made possible through dynamic offset cancellation, which reduces the residual offset voltage normally caused by device over molding, temperature dependencies, and thermal stress. Each device includes on a single silicon chip a voltage regulator, Hall-voltage generator, small-signal amplifier, chopper stabilization, Schmitt trigger, and an open-drain output to sink up to 20mA.

An onboard regulator permits with supply voltages of 2.5 to 24V which makes the device suitable for a wide range of industrial and automotive applications

The device is available in a 3-pin SIP package (UA) and a 3-pin SOT-23 style package (SO). Both are lead (Pb) free, with 100% matte tin leadframe plating.

## Device Information

Part Number	Packing	Mounting	Ambient, T <sub>A</sub>	B <sub>OP</sub> (Typ.)	B <sub>RP</sub> (Typ.)
SC2430UA	Bulk, 1000 pieces/bag	SIP3	-40°C to 150°C	+2.0mT	+1.5mT
SC2430SO-N	Reel, 3000pieces/reel	SOT-23		-2.0mT	-1.5mT
SC2432UA	Bulk, 1000 pieces/bag	SIP3	-40°C to 150°C	+2.5mT	+2.0mT
SC2432SO	Reel, 3000pieces/reel	SOT-23		-2.5mT	-2.0mT
SC2432SO-N	Reel, 3000pieces/reel	SOT-23			
SC2434UA	Bulk, 1000 pieces/bag	SIP3	-40°C to 150°C	+7.0mT	+5.5mT
SC2434SO	Reel, 3000pieces/reel	SOT-23		-7.0mT	-5.5mT
SC2434SO-N	Reel, 3000pieces/reel	SOT-23			
SC2436UA	Bulk, 1000 pieces/bag	SIP3	-40°C to 150°C	+10.0mT	+8.5mT
SC2436SO	Reel, 3000pieces/reel	SOT-23			
SC2438UA	Bulk, 1000 pieces/bag	SIP3	-40°C to 150°C	+12.0mT	+9.5mT
SC2438SO	Reel, 3000pieces/reel	SOT-23			

## Terminal configuration and functions

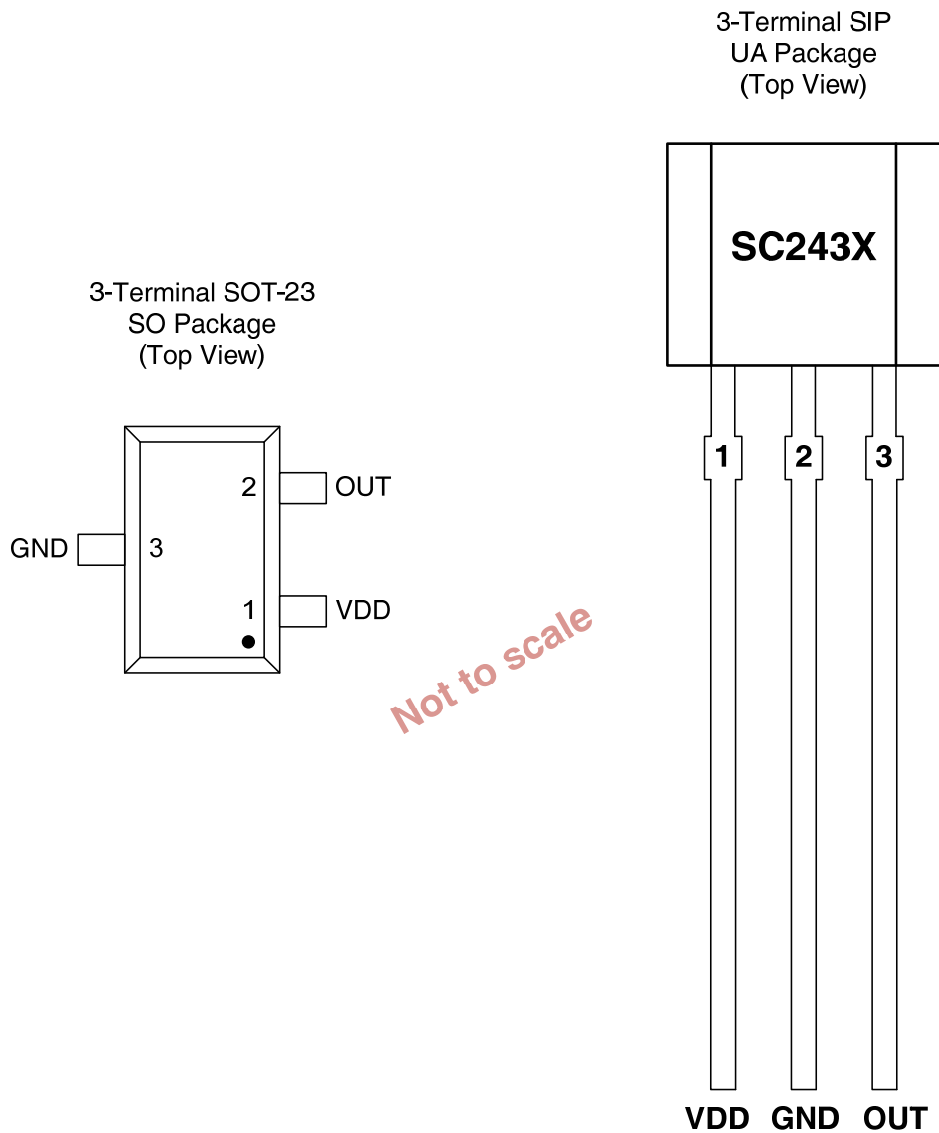

Name	Terminal		Type	Description
	Number			
	UA	SO		
VDD	1	1	PWR	2.5 to 24 V power supply
GND	2	3	Ground	Ground terminal
OUT	3	2	Output	Open-drain output

## Absolute Maximum Ratings

over operating free-air temperature range (unless otherwise noted) <sup>(1)</sup>

Parameter	Symbol	Min.	Max.	Units
Power supply voltage	V <sub>DD</sub>	-28 <sup>(2)</sup>	28	V
Output terminal voltage	V <sub>OUT</sub>	-0.5	28	V
Output terminal current sink	I <sub>SINK</sub>	0	30	mA
Operating ambient temperature	T <sub>A</sub>	-40	150	°C
Maximum junction temperature	T <sub>J</sub>	-55	165	°C
Storage temperature	T <sub>STG</sub>	-65	175	°C

<sup>(1)</sup>Stresses above those listed here may cause permanent damage to the device. Exposure to absolute maximum rating conditions for extended periods may affect device reliability.

<sup>(2)</sup>Ensured by design.

## ESD Protection

Human Body Model (HBM) tests according to: standard AEC-Q100-002

Parameter	Symbol	Min.	Max.	Units
ESD-Protection	V <sub>ESD</sub>	-4	4	KV

## Thermal Characteristics

Symbol	Parameter	Test Conditions	Rating	Units
R <sub>θA</sub>	UA Package thermal resistance	Single-layer PCB, with copper limited to solder pads	166	°C/W
R <sub>θA</sub>	SO Package thermal resistance	Single-layer PCB, with copper limited to solder pads	228	°C/W

## Electrical Characteristics

over operating free-air temperature range ( $V_{DD} = 5.0V$ , unless otherwise noted)

Symbol	Parameter	Test Conditions	Min.	Typ.	Max.	Units
$V_{DD}$	Operating voltage <sup>(1)</sup>	$T_J < T_{J(Max.)}$	2.5	--	24	V
$V_{DDR}$	Reverse supply voltage		-28	--	--	V
$I_{DD}$	Operating supply current	$V_{DD}=2.5$ to 24 V, $T_A=25^\circ C$	0.8	1.6	2.0	mA
		$V_{DD}=2.5$ to 24 V, $T_A=125^\circ C$	0.8	1.7	2.0	mA
$t_{on}$	Power-on time		--	35	50	$\mu S$
$I_{QL}$	Off-state leakage current	Output Hi-Z	--	--	3	$\mu A$
$R_{DS(on)}$	FET on-resistance	$V_{DD}=5V$ , $I_O=10mA$ , $T_A=25^\circ C$	--	20	--	$\Omega$
		$V_{DD}=5V$ , $I_O=10mA$ , $T_A=125^\circ C$	--	30	--	$\Omega$
$t_d$	Output delay time	$B=B_{RP}$ to $B_{OP}$	--	15	25	$\mu S$
$t_r$	Output rise time (10% to 90%)	$R1=1Kohm$ $C_o=50pF$	--	--	0.5	$\mu S$
$t_f$	Output fall time (90% to 10%)	$R1=1Kohm$ $C_o=50pF$	--	--	0.2	$\mu S$

<sup>(1)</sup> Maximum voltage must be adjusted for power dissipation and junction temperature, see Thermal Characteristics

## Magnetic Characteristics

over operating free-air temperature range (unless otherwise noted)

Symbol	Parameter	Test Conditions	Min.	Typ.	Max.	Units
$f_{BW}$	Bandwidth		20	--	--	kHz
<b>SC2430 +2.0 / +1.5 mT</b>						
$B_{OP}$	Operated point	$T_A=25^\circ\text{C}$	1.0	2.0	3.0	mT
$B_{RP}$	Release point		0.5	1.5	2.5	mT
$B_{HYS}$	Hysteresis		--	0.5	--	mT
<b>SC2432 +2.5 / +2.0 mT</b>						
$B_{OP}$	Operated point	$T_A=25^\circ\text{C}$	1.5	2.5	3.5	mT
$B_{RP}$	Release point		1.0	2.0	3.0	mT
$B_{HYS}$	Hysteresis		--	0.5	--	mT
<b>SC2434 +7.0 / +5.5 mT</b>						
$B_{OP}$	Operated point	$T_A=25^\circ\text{C}$	6.0	7.0	8.0	mT
$B_{RP}$	Release point		4.5	5.5	6.5	mT
$B_{HYS}$	Hysteresis		--	1.5	--	mT
<b>SC2436 +10.0 / +8.5 mT</b>						
$B_{OP}$	Operated point	$T_A=25^\circ\text{C}$	9.0	10.0	11.0	mT
$B_{RP}$	Release point		7.5	8.5	9.5	mT
$B_{HYS}$	Hysteresis		--	1.5	--	mT
<b>SC2438 +12.0 / +9.5 mT</b>						
$B_{OP}$	Operated point	$T_A=25^\circ\text{C}$	10.0	12.0	14.0	mT
$B_{RP}$	Release point		7.5	9.5	11.5	mT
$B_{HYS}$	Hysteresis		--	2.5	--	mT

$1\text{mT}=10\text{Gs}$

Magnetic flux density,  $B$ , is indicated as a negative value for North-polarity magnetic fields, and as a positive value for South-polarity magnetic fields.

### Characteristic Data

**$I_{DD}$  vs  $V_{DD}$**

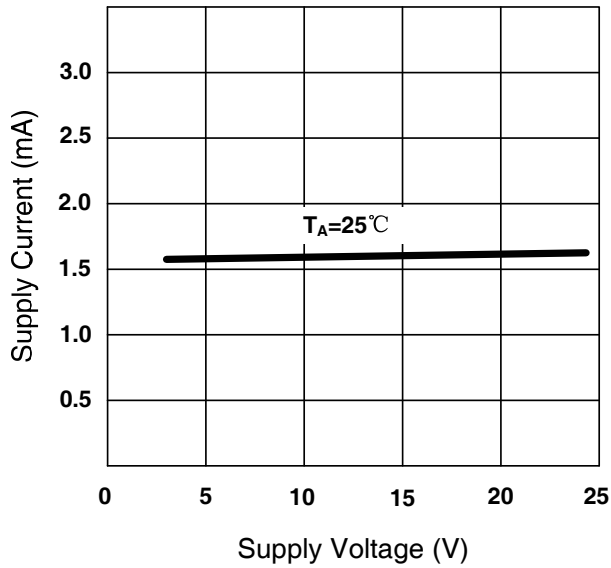

**$I_{DD}$  vs  $T_A$**

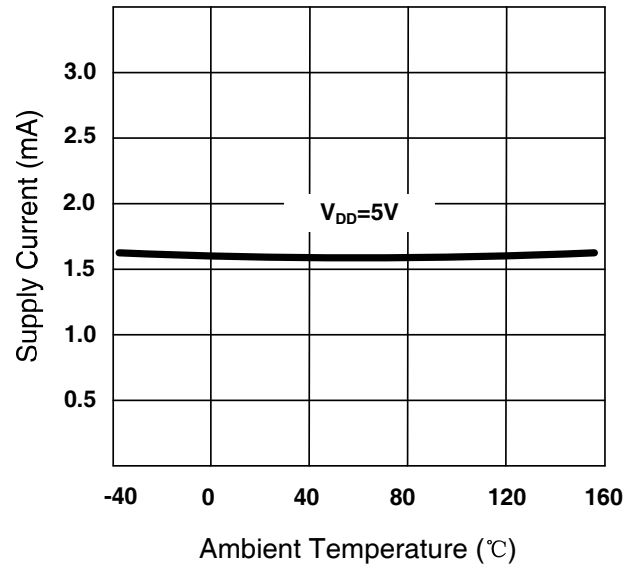

**$V_{Q(sat)}$  vs  $V_{DD}$**

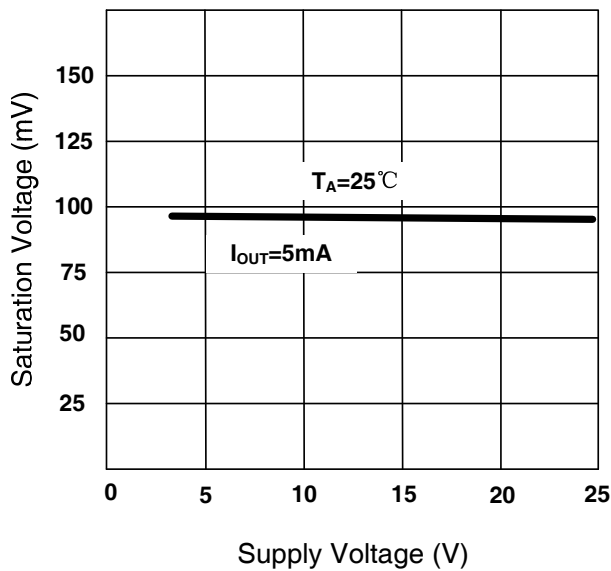

**$V_{Q(sat)}$  vs  $T_A$**

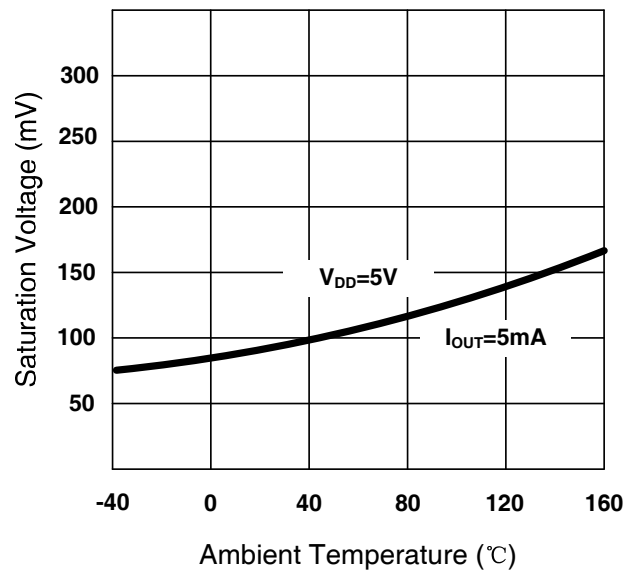

### Characteristic Data (Continued)

**SC2430**  
 **$B_{OP}$  and  $B_{RP}$  vs  $T_A$**

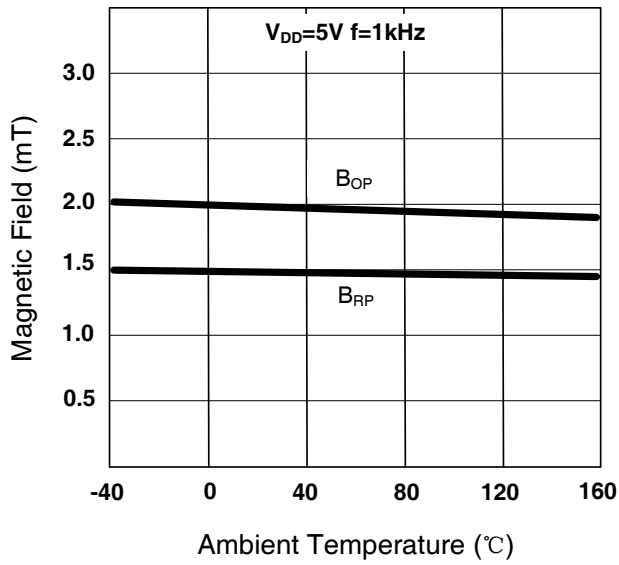

**SC2430**  
 **$B_{HYS}$  vs  $T_A$**

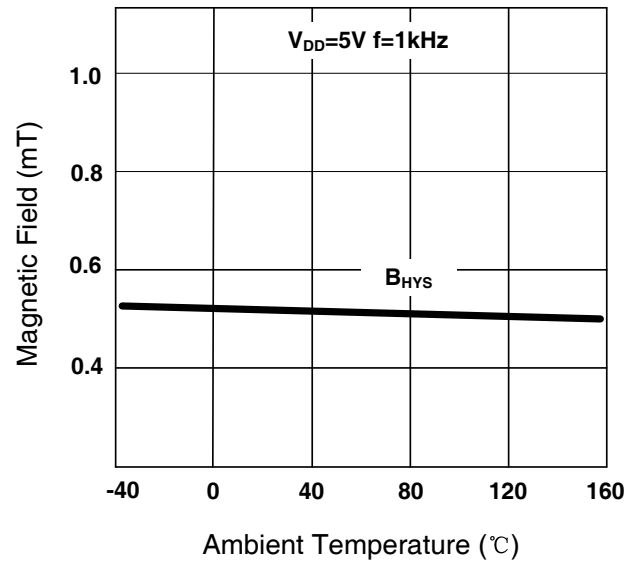

**SC2432**  
 **$B_{OP}$  and  $B_{RP}$  vs  $T_A$**

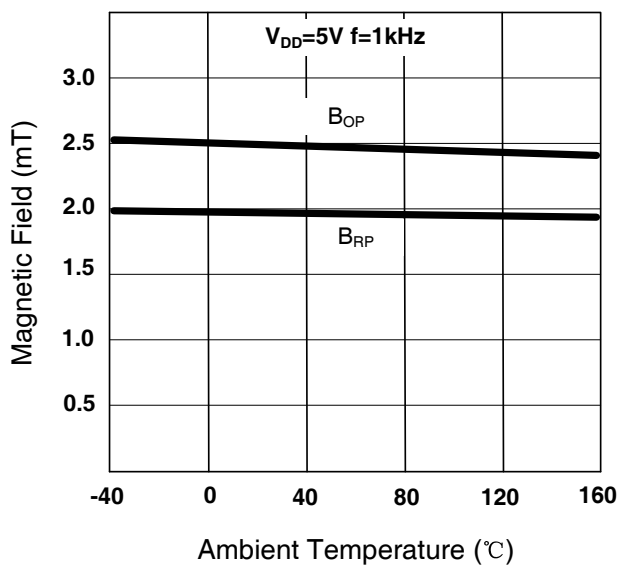

**SC2432**  
 **$B_{HYS}$  vs  $T_A$**

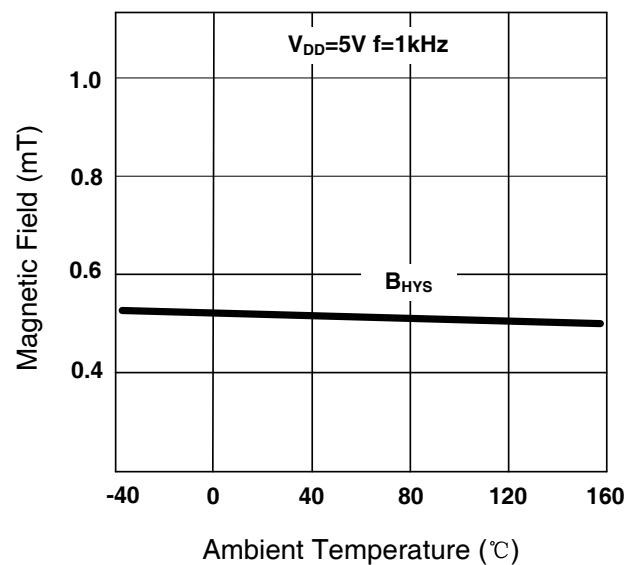



Characteristic Data (Continued)

**SC2434**  
**B<sub>OP</sub> and B<sub>RP</sub> vs T<sub>A</sub>**

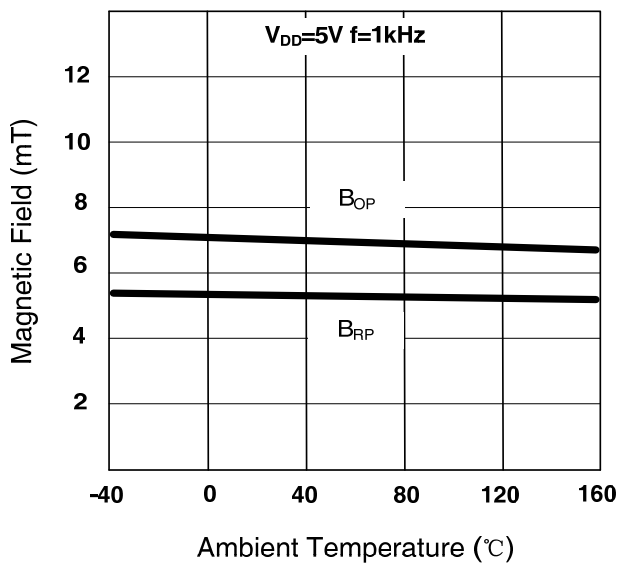

**SC2434**  
**B<sub>HYS</sub> vs T<sub>A</sub>**

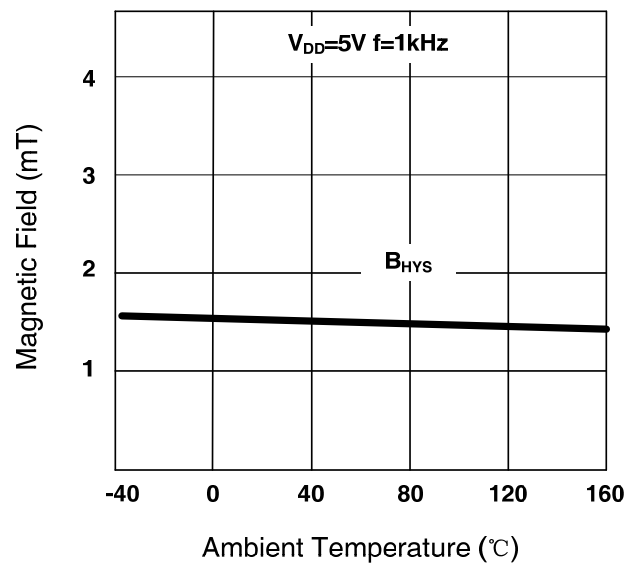

**SC2436**  
**B<sub>OP</sub> and B<sub>RP</sub> vs T<sub>A</sub>**

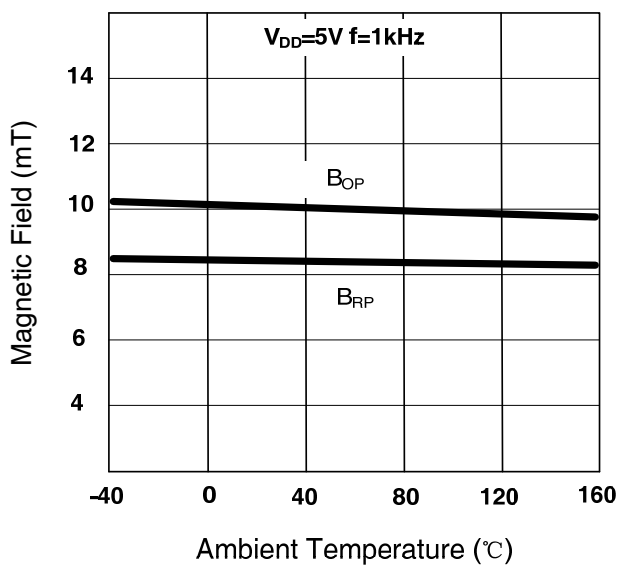

**SC2436**  
**B<sub>HYS</sub> vs T<sub>A</sub>**

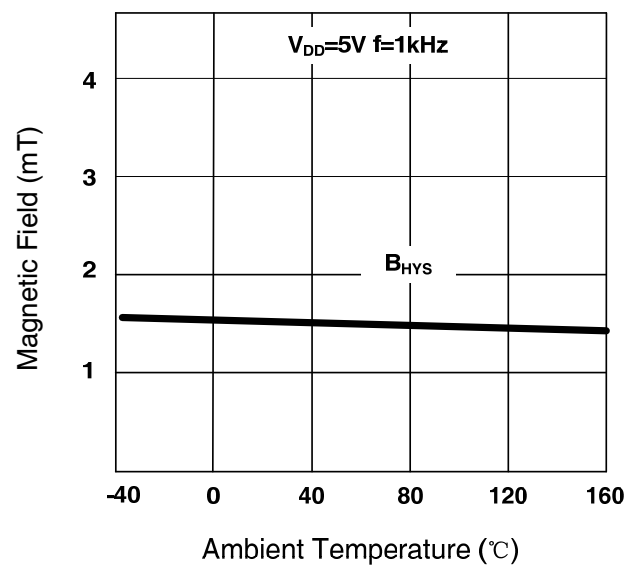

**Characteristic Data (Continued)**

**SC2438**  
 **$B_{OP}$  and  $B_{RP}$  vs  $T_A$**

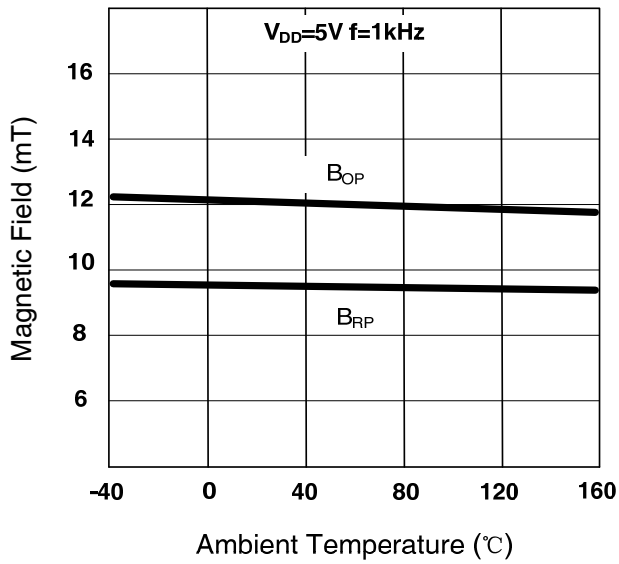

**SC2438**  
 **$B_{HYS}$  vs  $T_A$**

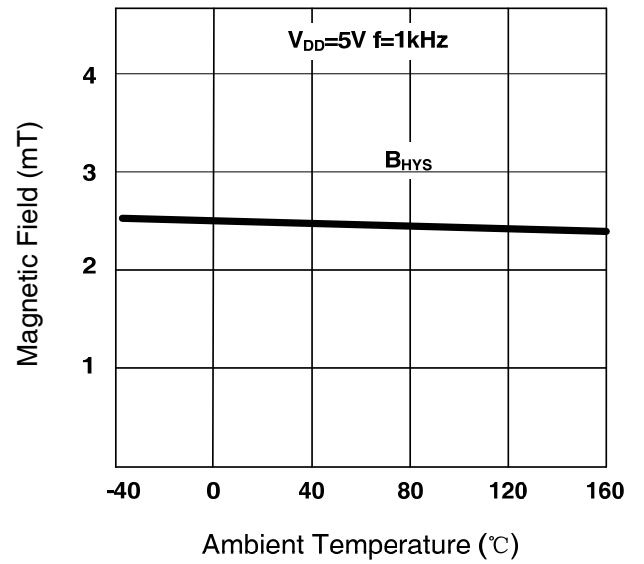

## Function Description Overview

The SC243X device is a chopper-stabilized Hall sensor with a digital latched output for magnetic sensing applications. The device can be powered with a supply voltage between 2.5 and 24V, and continuously survives continuous -28V reverse-battery conditions. The device does not operate when -28 to 2.2V is applied to the VDD terminal (with respect to the GND terminal). In addition, the device can withstand voltages up to 40V for transient durations.

The output of SC243X switches low (turns on) when a magnetic field (South polarity) perpendicular to the Hall element exceeds the operate point threshold,  $B_{OP}$ . After turn-on, the output is capable of sinking 20mA and the output voltage is  $V_{Q(sat)}$ . When the magnetic field is reduced below the release point,  $B_{RP}$ , the device output goes high (turns off). The difference in the magnetic operate and release points is the hysteresis,  $B_{HYS}$ , of the device. This built-in hysteresis allows clean switching of the output even in the presence of external mechanical vibration and electrical noise.

An external output pull-up resistor is required on the OUT terminal. The OUT terminal can be pulled up to  $V_{DD}$  or to a different voltage supply. This allows for easier interfacing with controller circuits.

## Functional Block Diagram

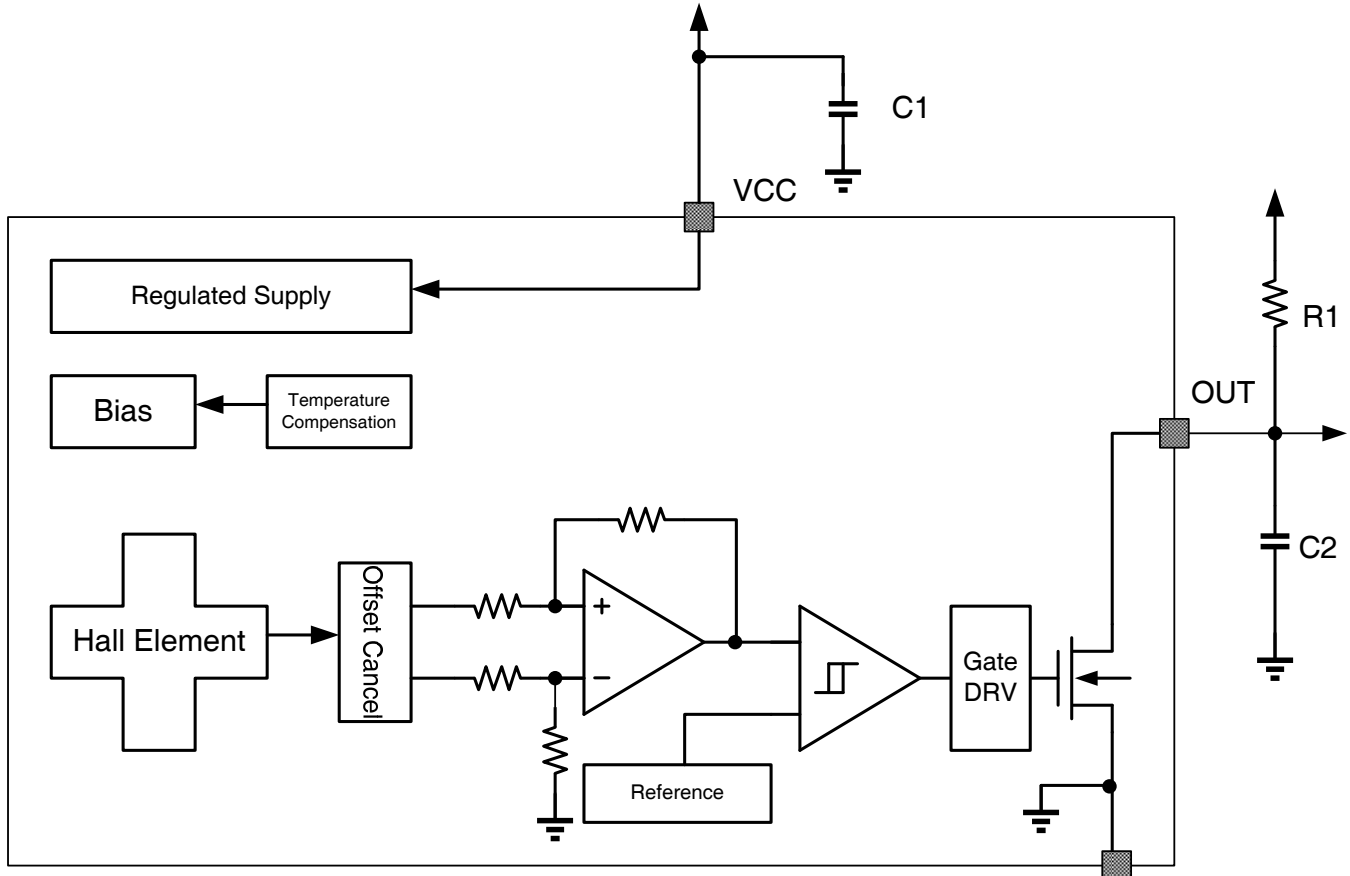

## Field Direction Definition

A positive magnetic field is defined as a South pole near the marked side of the package.

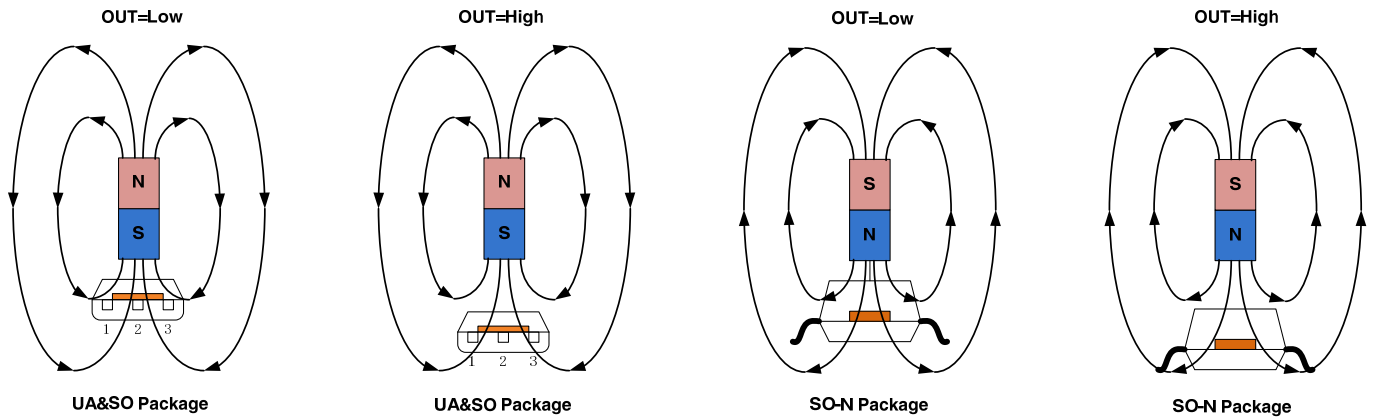

## Transfer Function

Powering-on the device in the hysteresis region, less than  $B_{OP}$  and higher than  $B_{RP}$ , allows an indeterminate output state. The correct state is attained after the first excursion beyond  $B_{OP}$  or  $B_{RP}$ . If the field strength is greater than  $B_{OP}$ , then the output is pulled low. If the field strength is less than  $B_{RP}$ , the output is released.

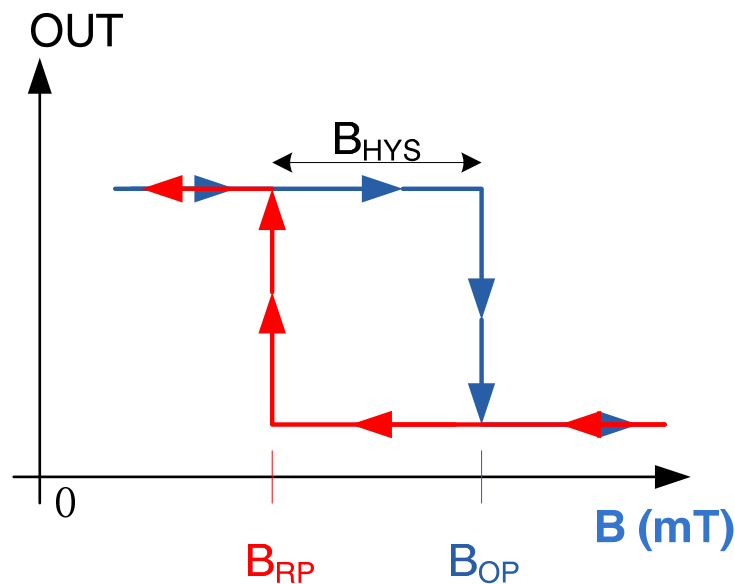

## Typical Application

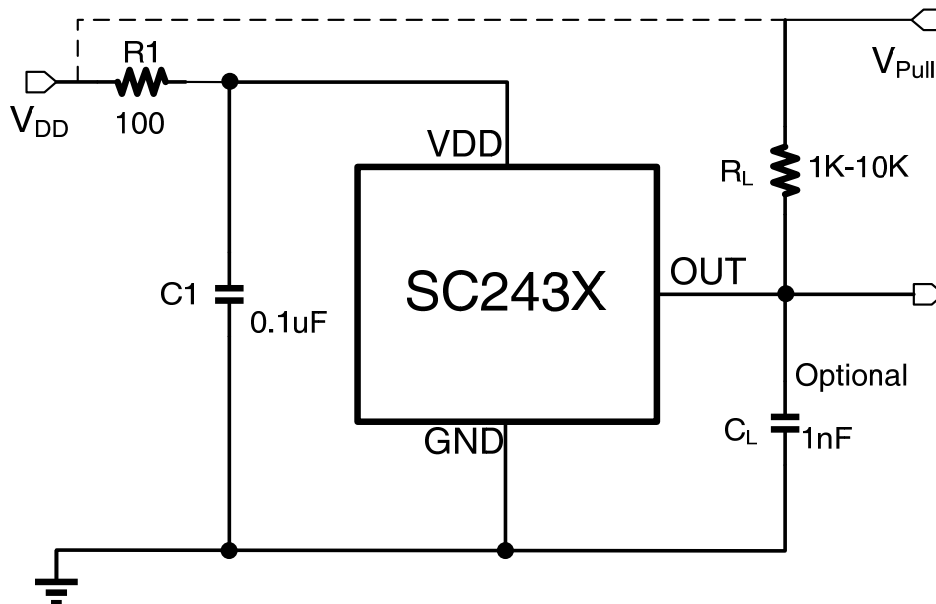

The SC243X contains an on-chip voltage regulator and can operate over a wide supply voltage range. In applications that operate the device from an unregulated power supply, transient protection must be added externally. For applications using a regulated line, EMI/RFI protection may still be required. R1 is for improved CI performance, and could be 100 or 200  $\Omega$  typically.

The SC243X device output stage uses an open-drain NMOS, and it is rated to sink up to 20mA of current. For proper operation, calculate the value of the pull-up resistor  $R_L$  is required. The size of  $R_L$  is a tradeoff between OUT rise time and the load capacity when OUT is pulled low. A lower current is generally better, however faster transitions and bandwidth require a smaller resistor for faster switching.

Select a value for  $C_L$  based on the system bandwidth specifications as:

$$2 \times f \text{ (Hz)} = \frac{1}{2\pi \times R \times C}$$

Most applications do not require this  $C_L$  filtering capacitor.

$V_{PULL}$  is not restricted to  $V_{DD}$ , and could be connected to other voltage reference. The allowable voltage range of this terminal is specified in the Absolute Maximum Ratings.

## Mechanical Dimensions

### 3-Terminal UA Package

Dimension:mm

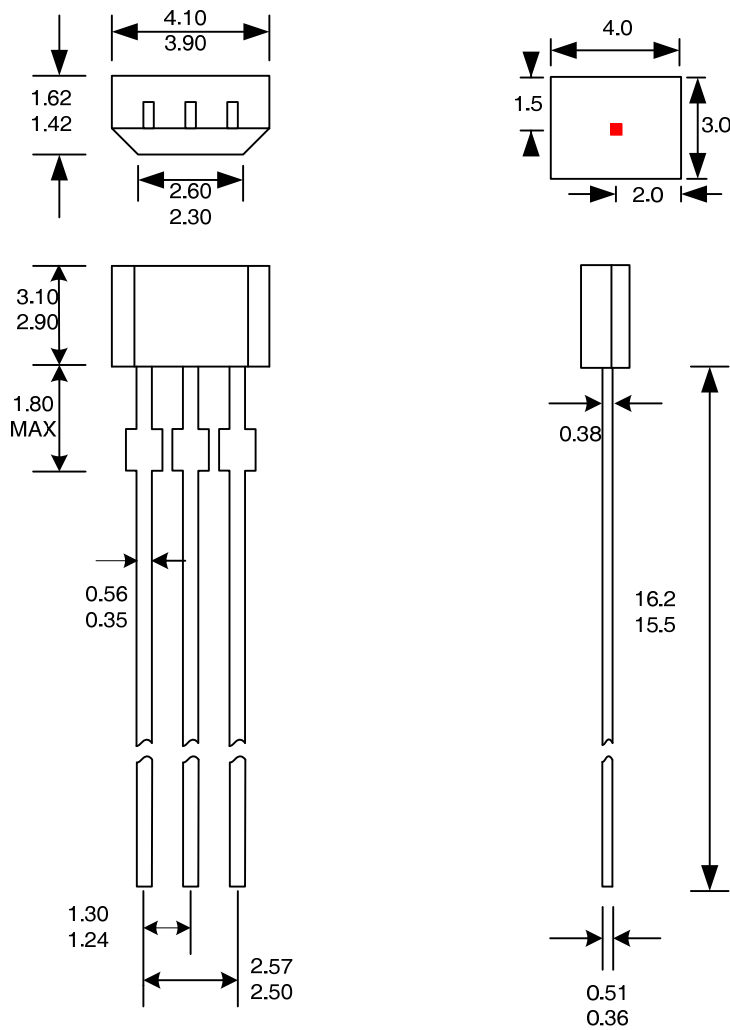

**Notes:**

1. Exact body and lead configuration at vendor's option within limits shown.
2. Height does not include mold gate flash.

Where no tolerance is specified, dimension is nominal.

## Mechanical Dimensions

### 3-Terminal SO Package

Dimension:mm

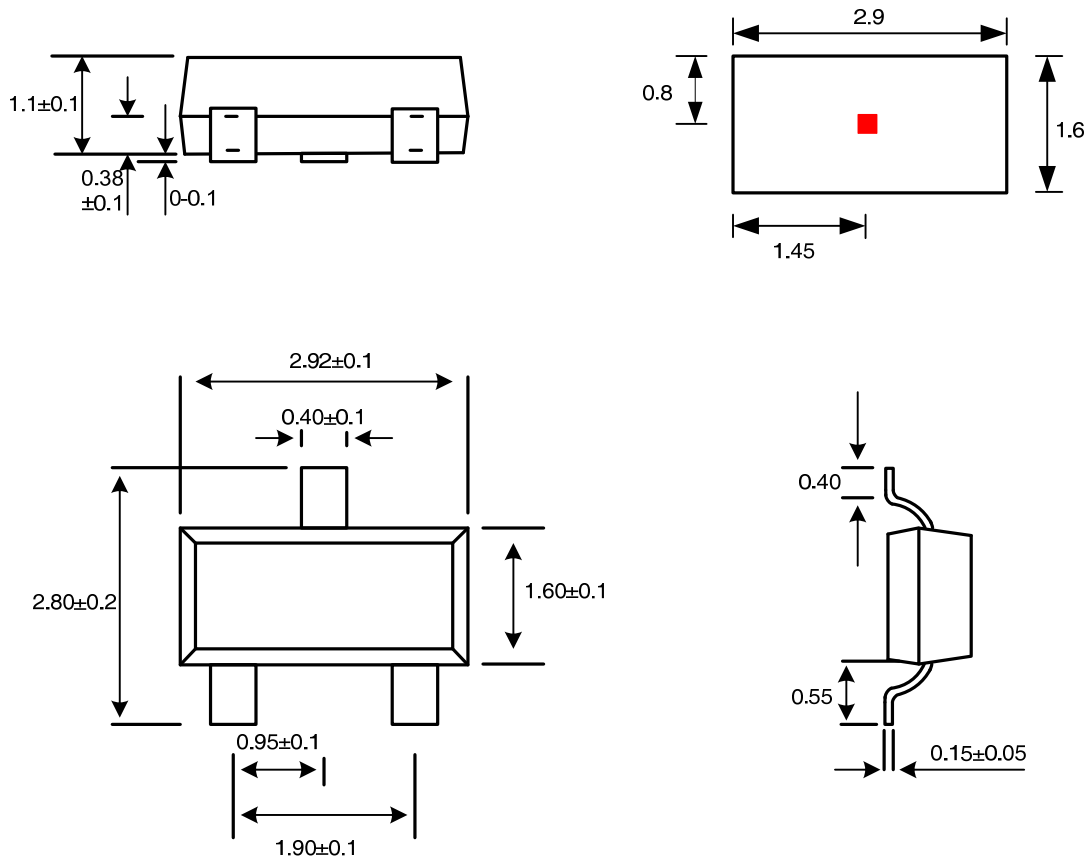

**Notes:**

1. Exact body and lead configuration at vendor's option within limits shown.
2. Height does not include mold gate flash.

Where no tolerance is specified, dimension is nominal.